

# OPERATING MANUAL



## RT-208GT

Room temperature controller

Version 5A01

## Table of contents.

Introduction.....	3
Description of the RT-208GT controller.....	4
Description of display symbols.....	5
Summary of the RT-208GT operation.....	6
Operation of the RT-208GT.....	7
User's parameters preview and setting.....	7
Night and daytime temperature.....	7
Program selection.....	7
Program edition (PRG 1, PRG 2, PRG 3, manual control program).....	8
Enforcing a change in the mode of work when a time scheduled program is under operation.....	8
Manual control program.....	9
Programs copying.....	9
Date and time.....	9
Display settings.....	10
Service parameters preview and setting.....	10
Language selection.....	10
Temperature range.....	10
Activation threshold.....	10
Boiler alarms.....	11
Connection with the boiler controller.....	11
Sensors.....	12
Sensors correction.....	14
Service password.....	14
Default settings.....	14
Antifreeze program.....	14
Technical specification.....	15
Schematics of connecting the RT-208GT to the RS-485 data transmission connector.....	16
Schematics of connecting the RT-208GT to the RK-2006LPG/LPG2 boiler controller.....	17

### Application.

The RT-208GT controller is a high quality microprocessor device designed for controlling the room temperature. The controller continuously makes measurements both of the room temperature, outside temperature and the boiler temperature and shows the values directly on the display.

### Connection.

The controller has been designed to be installed on a flat surface (e.g. wall). It should not be installed in rooms with increased air humidity, e.g. bathrooms, or in rooms with the poor air circulation, or next to source of heat. Connecting cables must not be damaged or compressed - this might result in the controller faulty operation and its damage. The controller should be installed at the level of roughly 150 cm on the inside wall in the environment of undisturbed air circulation, in a place not exposed to sunshine

Controller installation:

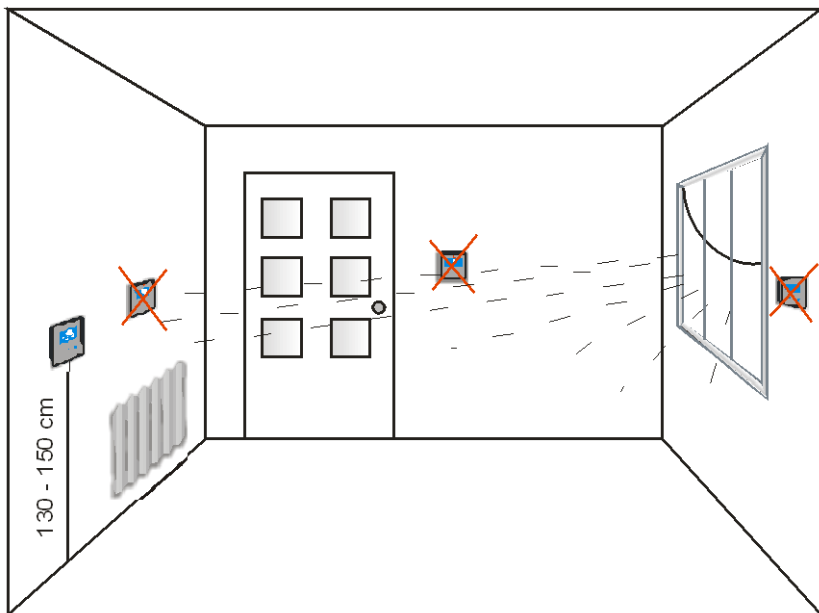

**KEY company is not liable for potential damages that might occur due to improper connection, installment or usage of the device.**

## RT-208GT controller description.

On the front cover of the controller there is a backlit LCD display as well as three function buttons.

### LCD Symbol.

- 1 - day of the week
- 2 - hour
- 3 - outside temperature sensor
- 4 - outside temperature
- 5 - programmed temperature
- 6 - room temperature
- 7 - mode of work (day/night)
- 8 - week program number
- 9 - boiler temperature sensor
- 10 - boiler temperature
- 11 - pump work indicator

### Function buttons.

- 12 - mode of work change and change confirmation button
- 13 - multifunction knob and change confirmation button
- 14 - MENU/exit button

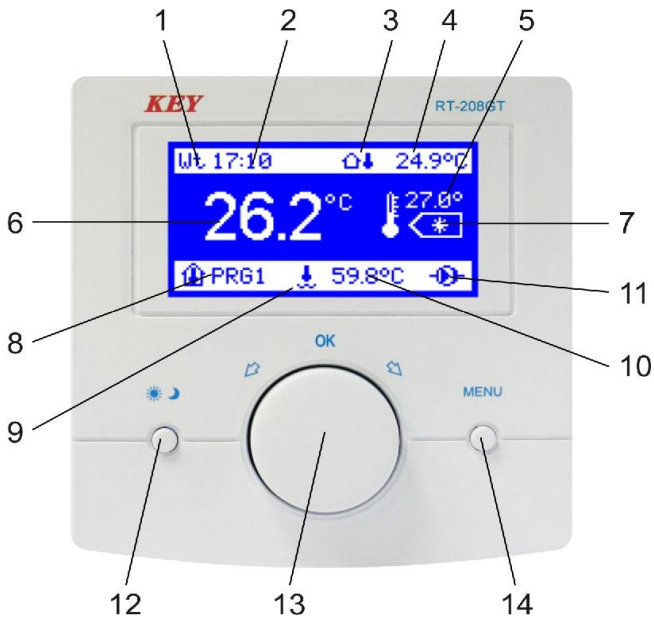

Picture 1. Front cover of the RT-208GT controller.

## Description of the display symbols.

### 1,2. Day of the week and an hour.

When in the regular mode of work, the current day of the week and time are displayed by the controller.

### 3. Outside temperature sensor.

### 4. Outside temperature.

When the outside temperature sensor is connected to the controller, the indicator will keep the user informed about the temperature outside the building.

### 5. Programmed temperature.

The controller displays the temperature programmed for the room.

### 6. The indicator shows the value of temperature inside.

### 7. Raising and lowering the (day/night) temperature mode of work.

The symbol of the sun (☀) in this place of the display indicates that the controller operates in the daytime mode of work. When the symbol of the moon is shown (☾), the controller is in the mode of lowered temperature, the so called night mode. The (OFF) word here indicates the controller is turned off and operates in the antifreeze mode of work.

### 8. Program number.

This is the number of the week time scheduled program which is being currently carried out. It is possible for the user to define three different week time scheduled programs. The (OFF) word displayed here indicates the controller is turned off and operates in the antifreeze mode of work.

### 9. Boiler temperature sensor.

### 10. Boiler temperature.

When the boiler temperature sensor is connected to the controller, the indicator displays the value of the boiler water temperature.

### 11. Boiler work indicator.

When the boiler is turned on, the pump symbol will be shown on the display

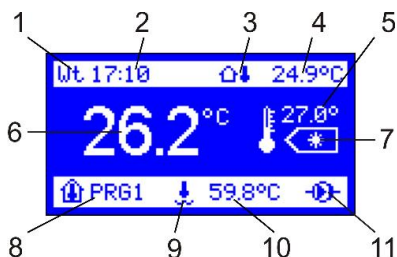

## Summary of the RT-208GT operation.

The device has been designed for room temperature control and when its value will be lower than the programmed one, the controller will activate the boiler, and the pump work symbol will be shown next to the boiler temperature on the display. Once the temperature programmed for the room is reached, the pump work symbol will be off, the controller will turn off the boiler and switch into the standby mode. At any moment the programmed temperature can be changed by turning the knob. For instance, when the controller operates in the daytime mode, by turning the knob the desired temperature is set, and pressing the knob will confirm the user's choice. When the change in the mode of work button has been pressed (☀️🌙), we select the night mode, then we set the desired temperature with the knob and confirm the change (pressing the knob) - the controller returns to its regular work.

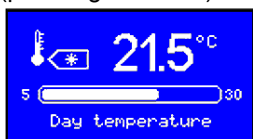

**CAUTION!** When the outside temperature and boiler temperature sensors are not used, measurement inputs of the sensors might be used to, e.g. measurement of any additional rooms temperature.

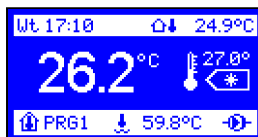

## Properties of RT-208GT.

- week schedule programming (24/7)
- readable backlit LCD display
- possibility of reading and setting all the boiler parameters
- programming and temperature measurement with up to 0.1 C accuracy
- 3 user-defined programs + manual program
- programs copying
- language selection
- time and date setting
- display settings (operation lightness, standby brightness, contrast)
- room temperature measurement
- outside temperature measurement
- boiler temperature measurement
- possibility of temperature measurement in three different rooms
- sensors correction
- hysteresis of boiler activation
- return to default settings
- boiler overheating alarm, fuel shortage alarm
- possibility of securing the default settings with a password
- antifreeze program
- easy to install, simple to operate

## Operation of the RT-208GT.

To make the controller more user-friendly all its functions have been divided into groups. At our disposal there are user's and service settings. To make changes in these groups, one should enter the user's menu (press the MENU or OK button once) or the service mode (press and hold for about 5 sec. the MENU button).

### Description of user's parameters.

#### 1. Programmed temperatures.

Pressing the MENU button (14) or OK multifunctional knob (13) will result in displaying the particular groups of parameters that can be edited and changed. The first visible group where changes can be introduced is the backlit group "Programmed temperatures". By turning the knob we can move between the particular groups. The indicator of a group that can be edited is then backlit.



#### Setting the night and daytime temperatures.

Pressing the knob when the group "Programmed temperatures" is displayed will result in editing the given group and on the display two temperatures will be shown - day and night one. These are the group parameters that can be changed. Each parameter that can be changed will be backlit. By turning the knob the user sets the desired daytime temperature, next the change is confirmed with pressing the knob, and then we set the night temperature. When the night temperature is set, we confirm the change by pressing the knob, next we exit the settings mode by pressing the MENU button - and the controller returns to its regular mode of work.



#### 2. Program selection.

Next item in the user's MENU is a group "Program selection". (the controller is preprogrammed to use a manual program). Pressing the knob when the group is displayed will result in displaying the list of 24-hour programs that might be programmed (PRG1, PRG2, PRG3) and an additional manual program. By turning the knob we select the program that will be executed by the controller. To confirm the changes press the OK button, then press the MENU button to exit the settings mode - the controller returns to its regular mode of work.

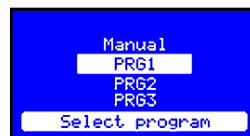

### 3. Program edition (PRG1, PRG2, PRG3, manual program).

Within the group of parameters three different week time scheduled programs can be defined according to the user's own needs. Pressing the knob when editing a group, e.g. "Program 1 edition" will result in displaying all the parameters of the group that can be changed. The user can determine the hours between which the night and daytime temperature will be fulfilled. There will be shown on the display: day of the week, the hour showing the marker position, edited program number as well as time range with days of the week displayed for the given program. Once the knob is pressed, one of the two (☀) (☾) symbols will be shown by the empty middle marker above the scale. By turning the knob the marker can be relocated between particular hours of each day of the week. The symbol of the sun fills in the empty field above the scale, whereas the symbol of the moon cancels the marking. For instance, when there is an empty field above the time limit from 21.35 to 7.15, the controller during this time will operate under the night mode. However, when the field above the time range from 7.15 to 21.35 is filled in, the controller during this period of time will operate under the daytime mode.



Selecting with the OK button the marker itself allows the user to move the marker between the particular days of the week without introducing any changes. This is extremely practical, as at any moment the user can return to any given day of the week and make a correction without cancelling the parameters set earlier. Pressing the MENU button will result in displaying the window: "Save program changes?" Select "YES" and press the knob to confirm changes, next press the MENU button and the controller will resume its regular operation. Selecting "NO" will result in recovering the earlier saved program, and pressing the MENU button will close the question window and the controller will return to the program edition mode.

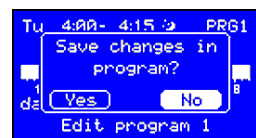

### Enforcing the change in the mode of work when under time scheduled program.

When the controller is under one of the three time scheduled programs defined by the user and it operates in the daytime mode of work, the night mode can be temporarily turned on. The same, when the controller is in the night mode of work, the daytime mode can be switched. After switching from the daytime to night mode, instead of the symbol of the sun (☀), the sign of (☾) the moon will be visible by the programmed temperature, and the ?current (e.g. PRG1) program number will blink alternately. There will appear the symbol of the moon in place of the displayed program. The change will remain active till the end of the current time limits under which the controller has been operating before the introduced changes.



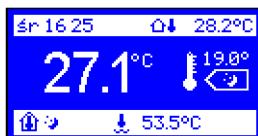
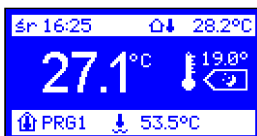
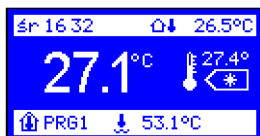

### Manual program.

Selecting the manual program while the group "Program selection" being edited results in stopping the time scheduled control. The controller will switch into the program of the continuous control. In the mode, night and daytime temperatures only are maintained with the week program deactivated.

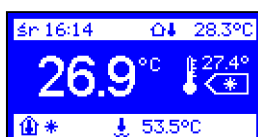
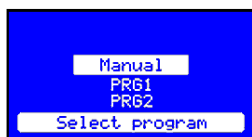

### 4. Programs copying.

The controller is provided with the function of copying programs of any given day of the week into any other day (all 1st, 2nd and 3rd programs included). The function allows to save time necessary to program the device.



Select the function "Programs copying" in the user's menu. There will be icons for each particular day of the week shown on the display. Select with the knob the day you want to copy, e.g. Monday and press the OK button. The list of the days of the week into which the selected day might be copied will be displayed. Select, e.g. Wednesday and confirm it by pressing the knob. The message "Daytime program copied" will appear - confirm it by pressing the knob again, and, to allow the controller resume its regular work, press the MENU button.

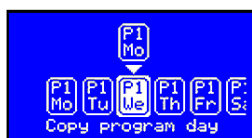

### 5. Time and date.

Select the function "Time and date" in the user's menu and, by turning the knob, change hours. To confirm the change press the knob. All remaining parameters should be treated in the same way. To exit the settings press the MENU button or set and confirm all the parameters.



## 6. Display settings.

Select the "Display settings" function in the menu to conform display to your own needs. Press the knob while the group of the parameters is edited to see



- operation lightness
- standby brightness
- contrast



## Description of service parameters.

Press and hold the MENU button for about 5 sec. to enter the service mode.

## 7. Language selection.

Select the "Language selection" function in the menu and press the OK button to allow the list of languages that could be selected. Select a language by turning the knob and confirm the change (press the knob) - the language of the program will be then changed to the selected one.



## 8. Temperature range.

Selecting the "Temperature range" function allows to set minimum and maximum values of temperature. The value of the maximum temperature set in this parameter will be both day and night maximum temperature that could be programmed, whereas the value of minimum temperature will be both day and night minimum temperature.

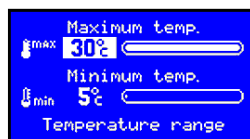

## 9. Activation threshold.

The parameter defines by how much the room temperature should be lowered when compared to the programmed temperature so that the boiler could be activated by the controller.

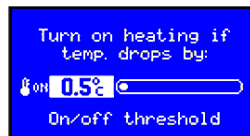

## 10. Boiler alarms.

Select the "Boiler alarms" function in the menu to set the maximum boiler temperature (temperature of overheating) and the minimum one (shortage of fuel temperature). When the boiler water temperature rises above the maximum programmed temperature, the alarm will be turned on - the boiler temperature indicator and the display will start to blink. The situation will repeat as well when the boiler water temperature lowers below the minimum programmed temperature. A sound device, activated by the alarm, can be connected to the controller.

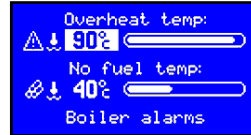
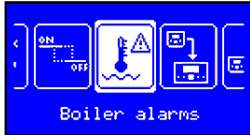

## 11. Connect to driver.

The function allows the user to connect the controller to the boiler driver and handle all the boiler parameters with the room controller. The boiler driver display is shown on the controller's screen - that is how all the boiler parameters can be regulated without necessity of visiting the boiler room.

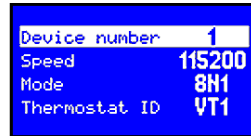

**CAUTION!** To cancel the connection with the boiler driver, press the day/night mode of work button and then the MENU button.

## 12. Parameters of connection.

They are the parameters that should be set to properly connect with the boiler driver.

**CAUTION! The connection parameters of the room controller must be equivalent with the data transmission parameters of the boiler driver.**

**Device number - 1..247** – allows to determine the number of device assigned to the driver and to avoid malfunction when a number of devices are connected to the bus.

**Speed - channel speed** – selection of RS-485 transmission speed. All the connected devices should have the same parameters set. Recommended speed of 115200; the speed can be changed unless no errors in transmission occur.

**Mode** - frame layout – allows to define data frame layout used in RS-485 transmission.

**Thermostat number VT1-VT4, MIX1-MIX4** – depending on whether the boiler driver controls one or two central heating systems, four room thermostats can be connected to each system.

**VT1–VT4** – first CH system.

**MIX1–MIX4** – second CH system.

**CAUTION!** When the room controller and the boiler driver have been connected with the data transmission connector, the jumper on the room thermostat input of the boiler driver should be removed and the thermostat number should be set in the room controller, e.g. VT-1 (first circuit) or MIX-1 (second circuit). When several room controllers have been connected, different thermostat numbers should be set in each of them.

A given circuit might be activated by any of the connected room controllers.

### 13. Sensors.

The device is equipped with the room temperature sensor and T1 and T2 sensor inputs that might be used to the boiler temperature and the outside temperature measurement or as an additional inside temperature sensor.

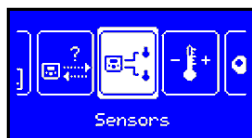

Control	Int.
Sensor T1	Out
Sensor T2	Boiler
Tout from RK	No
Tout to RK	Yes

Sensor T1	Out
Sensor T2	Boiler
Tout from RK	No
Tout to RK	Yes
Tb from RK	No

The temperature measured with the built-in sensor is displayed in the largest font. The user can define which sensor will be the main sensor controlling the boiler work when the inside temperature is measured in two or three different rooms.

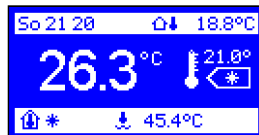

When the additional T1 sensor is programmed as the main one, the temperature measured with the sensor is shown on the display in the largest font, and next to the value there is the sensor's symbol. In this case the temperature value measured with the built-in sensor is shown in the top row of the display and marked with an image of a house with a thermometer inside.

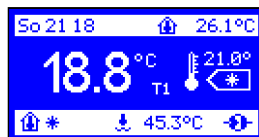

When the T1 sensor works as an additional sensor and not the main one, its symbol and value measured with it are shown in the top row of the display.



When the T1 sensor works as the outside temperature sensor, the value measured is also shown in the top row of the display and marked with a house with a thermometer outside.

When the additional sensor operates as the boiler temperature sensor, its symbol and the value measured are shown in the bottom row of the display.

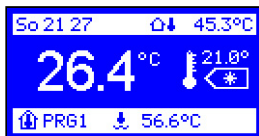

**Tout from RK** – the parameter allows the user to define whether the outside temperature measured with the outside temperature sensor connected to the boiler driver should be displayed by the room controller.

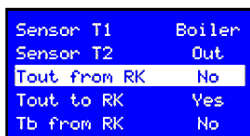

**Tout to RK** – the parameter allows the user to define whether the outside temperature measured with the sensor connected to the room controller should be read by the boiler driver.

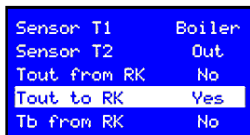

**Tb from RK** – the parameter allows the user to define whether the boiler temperature measured with the temperature sensor connected to the boiler driver should be displayed by the room controller

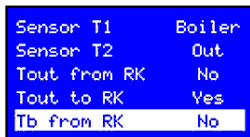

#### 14. Correction of sensors.

Long connecting cables might be the reason for faulty temperature measurements. The parameter allows the user to make corrections to this malfunction. Select the "Sensors correction" function in the user's menu and make any necessary changes in the inside, outside and boiler temperature sensors. Turn the multifunctional knob in each backlit indicator to select desired values.

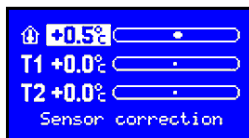
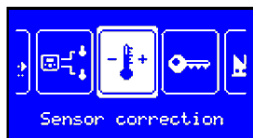

Confirm your settings (press the knob) and press the MENU button to allow the controller resume its regular work.

### 15. Set a password.

The parameter allows the user to set 5-digit access password to the service settings. Once the password has been typed in, the question "Save new password?" will be displayed - press the OK - and the password will be saved. In order to cancel the password, the default controller settings should be resumed



**CAUTION!** When the password has been forgotten, the user should press and hold the day/night mode of work button before the controller activation - the test screen will be displayed. Press and hold for about 10 sec. the OK button - and the question "Resume default settings?" will be shown. Select "YES" and confirm it with the OK button. To exit the test mode press the MENU button.

### 16. Default settings.

The controller is provided with three 24-hour programs and a manual one preprogrammed by the manufacturer. Select the "Default settings" in the user's menu to resume the settings. Press the knob when editing the parameter to display the question "Resume default settings?". Select YES and press the multifunctional knob to confirm the change - and the controller returns to the producer's settings



When the default settings have been resumed, the controller operates in the manual program mode. In the mode, the day and night temperatures are controlled only, with no time schedule. To activate full regulation one of the three 24-hour programs should be selected.

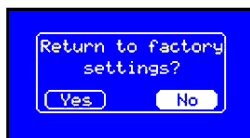

## 17. Antifreeze program.

The controller has been provided with the function protecting the room from freezing. When the temperature of boiler water lowers to 5 C, the burner will be activated. When the temperature rises above 5 C, the burner will be turned off and the controller will continue to protect a room from freezing

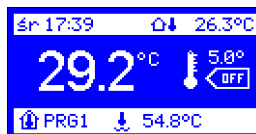
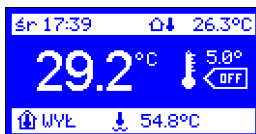
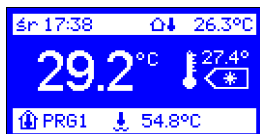

When the controller operates under one of the three week programs, press and hold for 3 sec. the (☀️🌙) button to stop the regulation. Then the controller moves to the antifreeze program and will maintain the temperature of 5 C. The "OFF" message will appear in place of the mode of work symbol, and "WYL" in place of the 24-hour program number. Additionally, the word "WYL" and the current (e.g. PRG1) program number will start to blink alternately. The change will remain active within the current time schedule under which the controller has been working, or until the button (☀️🌙) is pressed.

When the function is activated in the manual program mode, the protection from freezing works until it is turned off by pressing the change in the mode of work (☀️🌙) button.

### Technical specification:

Power supply	5:15 V, 30 mA
Temperature measurement range	-40:140 C
Temperature control range	5:30 C
Temperature measurement accuracy	0.1 C
Dimensions	96x98x36 mm

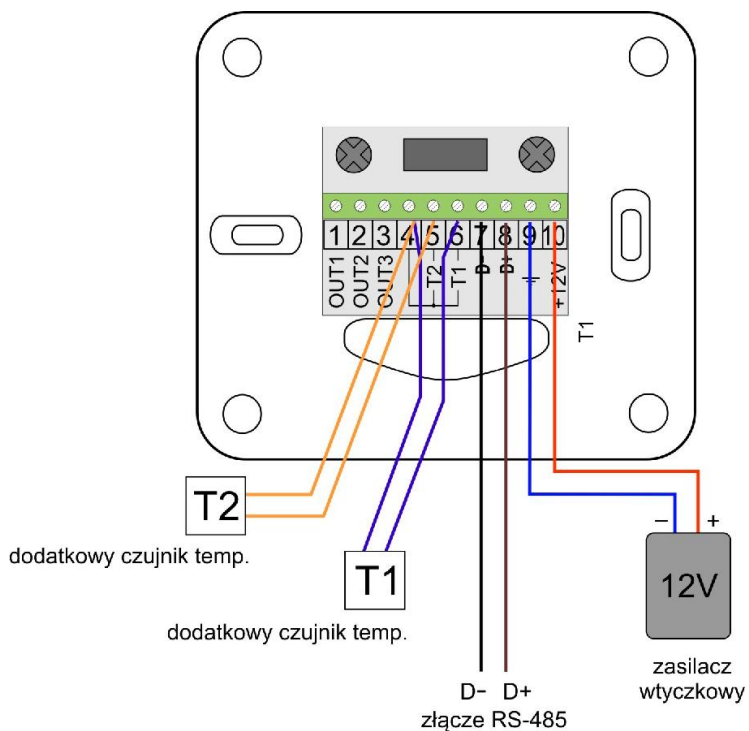

Schematics of connecting the RT-208GT to the RS-485 data transmission connector



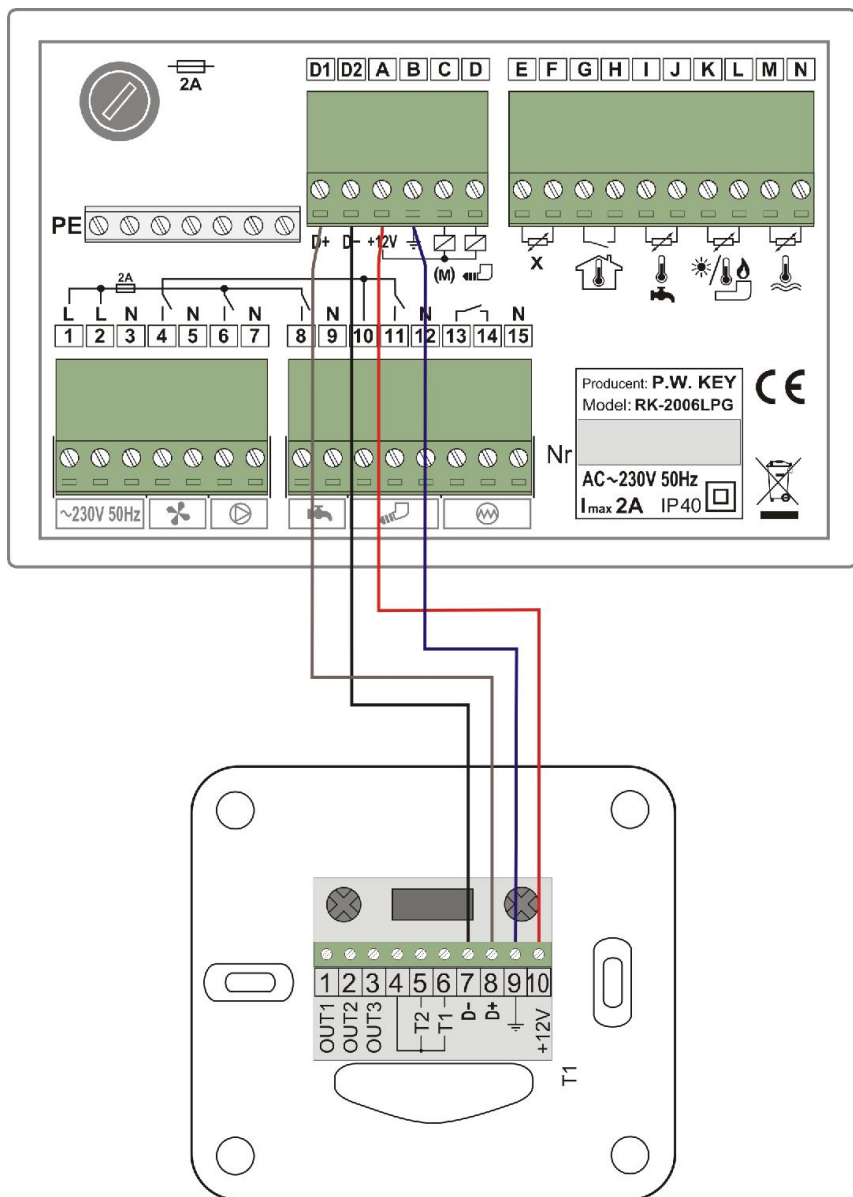

Schematics of connecting the RT-208GT room controller to the RK-2006LPG/LPG2 boiler driver





Producent:

P.W. KEY

11-200 Bartoszyce, ul. Bohaterów Warszawy 67

tel. (89) 763 50 50, fax. (89) 763 50 51

[www.pwkey.pl](http://www.pwkey.pl) e-mail: [pwkey@onet.pl](mailto:pwkey@onet.pl)