

# OPERATING MANUAL



## RT-208B

TEMPERATURE DAILY PROGRAMMER  
BOILER WITH ELECTRICALLY CONTROLLED BURNER

Version 5A01

## Table of contents.

Introduction.....	3
Description of the RT-208B controller.....	4
Description of display symbols.....	5
Summary of the RT-208B operation.....	6
Operation of the RT-208B.....	7
User's parameters preview and setting.....	7
Night and daytime temperature.....	7
Program selection.....	7
Program edition (PRG 1, PRG 2, PRG 3, manual control program).....	8
Enforcing a change in the mode of work when a time scheduled program is under operation.....	8
Manual control program.....	9
Programs copying.....	9
Date and time.....	9
Display settings.....	10
Service parameters preview and setting.....	10
Language selection.....	10
Temperature range.....	10
Activation threshold.....	10
Boiler alarms.....	11
Sensors correction.....	11
Service password.....	11
Default settings.....	12
Antifreeze program.....	12
Technical specification.....	12
Connection diagram of the RT-208B .....	13

### Application.

The RT-208B regulator is a modern microprocessor device designed for daily programming and boiler temperature control. The regulator continuously measures boiler temperature, outside temperature, indoor temperature and presents it directly on the display.

### Connection.

The controller has been designed to be installed on a flat surface (e.g. wall). It should not be installed in rooms with increased air humidity, e.g. bathrooms, or in rooms with the poor air circulation, or next to source of heat. Connecting cables must not be damaged or compressed - this might result in the controller faulty operation and its damage. The controller should be installed at the level of roughly 150 cm on the inside wall in the environment of undisturbed air circulation, in a place not exposed to sunshine

Controller installation:

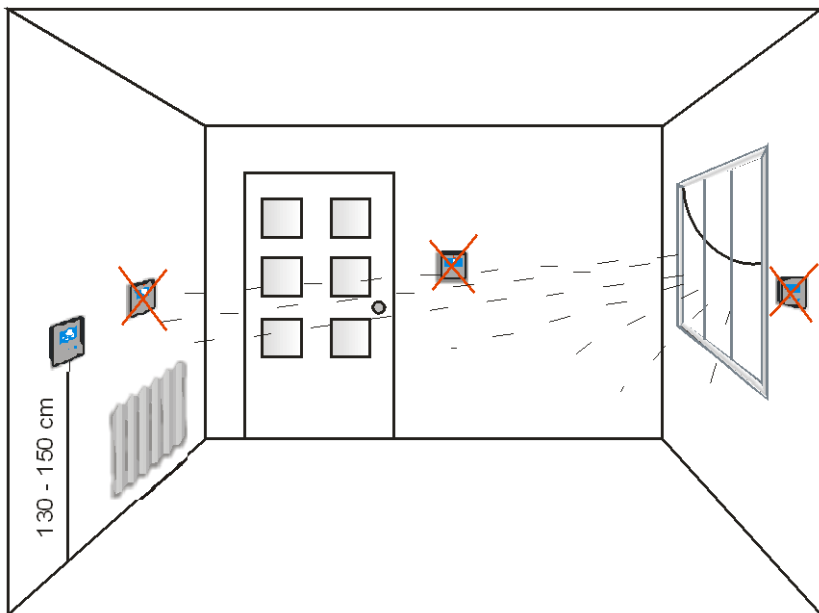

**KEY company is not liable for potential damages that might occur due to improper connection, installment or usage of the device.**

## RT-208B controller description.

On the front cover of the controller there is a backlit LCD display as well as three function buttons.

### LCD Symbol.

- 1 - day of the week
- 2 - hour
- 3 - outside temperature sensor
- 4 - outside temperature
- 5 - programmed temperature
- 6 - boiler temperature
- 7 - mode of work (day/night)
- 8 - week program number
- 9 - room temperature sensor
- 10 - room temperature
- 11 - boiler operation indicator

### Function buttons.

- 12 - mode of work change and change confirmation button
- 13 - multifunction knob and change confirmation button
- 14 - MENU/exit button

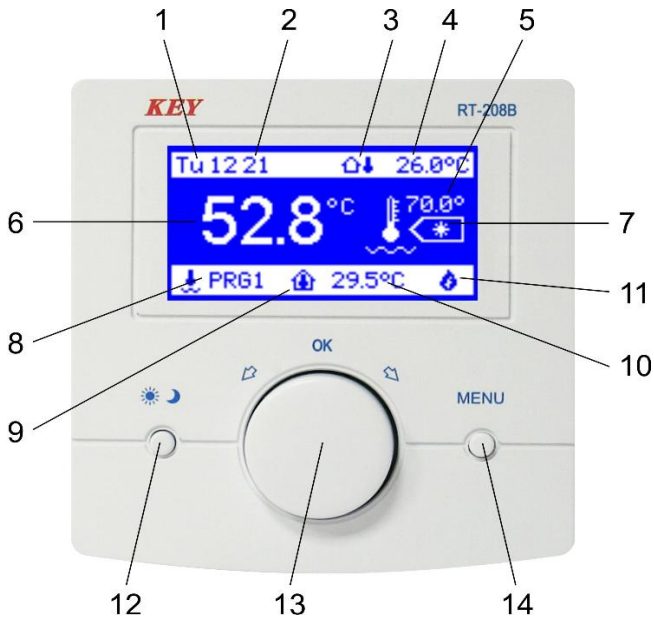

Picture 1. Front cover of the RT-208B controller.

## Description of the display symbols.

### 1,2. Day of the week and an hour.

When in the regular mode of work, the current day of the week and time are displayed by the controller.

### 3. Outside temperature sensor.

### 4. Outside temperature.

When the outside temperature sensor is connected to the controller, the indicator will keep the user informed about the temperature outside the building.

### 5. Programmed temperature.

The controller displays the temperature programmed for the room.

### 6. The indicator shows the value of temperature inside.

### 7. Raising and lowering the (day/night) temperature mode of work.

The symbol of the sun (☀) in this place of the display indicates that the controller operates in the daytime mode of work. When the symbol of the moon is shown (☾), the controller is in the mode of lowered temperature, the so called night mode. The (OFF) word here indicates the controller is turned off and operates in the antifreeze mode of work.

### 8. Program number.

This is the number of the week time scheduled program which is being currently carried out. It is possible for the user to define three different week time scheduled programs. The (OFF) word displayed here indicates the controller is turned off and operates in the antifreeze mode of work.

### 9. Room temperature sensor.

### 10. Room temperature.

The temperature of the room in which the regulator was installed

### 11. Boiler operation indicator.

If the boiler is switched on, the flame symbol appears on the display informing about the operation of the boiler burner.

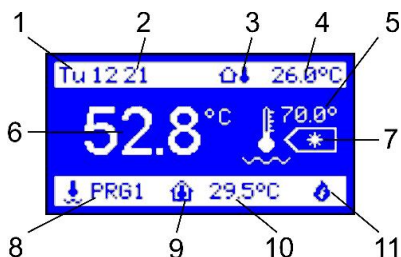

## Summary of the RT-208B operation.

Operation of the device consists in controlling the boiler temperature and in the event of it will be lower than the programmed regulator, the boiler will turn on and on the display in the lower right corner there will be a flame symbol informing about the boiler's operation. After reaching the preset temperature will go out the flame symbol, the regulator will turn the boiler off and it will go into standby mode. At any time by turning the knob we can change the set temperature. For example, if the regulator works in day mode by turning the knob set the desired temperature and confirm it by pressing the knob.

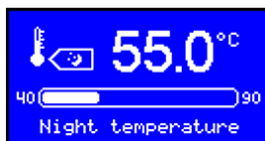
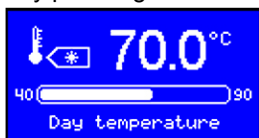

After pressing the change mode button (☀️🌙), select night mode, set with the knob required temperature and confirm the change (pressing the knob) - regulator returns to normal work.



## Properties of RT-208B.

- week schedule programming (24/7)
- readable backlit LCD display
- programming and temperature measurement with up to 0.1 C accuracy
- 3 user-defined programs + manual program
- programs copying
- language selection
- time and date setting
- display settings (operation lightness, standby brightness, contrast)
- room temperature measurement
- outside temperature measurement
- boiler temperature measurement
- possibility of temperature measurement in three different rooms
- sensors correction
- hysteresis of boiler activation
- return to default settings
- boiler overheating alarm, fuel shortage alarm
- possibility of securing the default settings with a password
- antifreeze program
- easy to install, simple to operate

## Operation of the RT-208B.

To make the controller more user-friendly all its functions have been divided into groups. At our disposal there are user's and service settings. To make changes in these groups, one should enter the user's menu (press the MENU or OK button once) or the service mode (press and hold for about 5 sec. the MENU button).

### Description of user's parameters.

#### 1. Programmed temperatures.

Pressing the MENU button (14) or OK multifunctional knob (13) will result in displaying the particular groups of parameters that can be edited and changed. The first visible group where changes can be introduced is the backlit group "Programmed temperatures". By turning the knob we can move between the particular groups. The indicator of a group that can be edited is then backlit.



#### Setting the night and daytime temperatures.

Pressing the knob when the group "Programmed temperatures" is displayed will result in editing the given group and on the display two temperatures will be shown - day and night one. These are the group parameters that can be changed. Each parameter that can be changed will be backlit. By turning the knob the user sets the desired daytime temperature, next the change is confirmed with pressing the knob, and then we set the night temperature. When the night temperature is set, we confirm the change by pressing the knob, next we exit the settings mode by pressing the MENU button - and the controller returns to its regular mode of work.



#### 2. Program selection.

Next item in the user's MENU is a group "Program selection". (the controller is preprogrammed to use a manual program). Pressing the knob when the group is displayed will result in displaying the list of 24-hour programs that might be programmed (PRG1, PRG2, PRG3) and an additional manual program. By turning the knob we select the program that will be executed by the controller. To confirm the changes press the OK button, then press the MENU button to exit the settings mode - the controller returns to its regular mode of work.

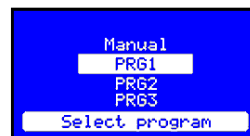

### 3. Program edition (PRG1, PRG2, PRG3, manual program).

Within the group of parameters three different week time scheduled programs can be defined according to the user's own needs. Pressing the knob when editing a group, e.g. "Program 1 edition" will result in displaying all the parameters of the group that can be changed. The user can determine the hours between which the night and daytime temperature will be fulfilled. There will be shown on the display: day of the week, the hour showing the marker position, edited program number as well as time range with days of the week displayed for the given program. Once the knob is pressed, one of the two (☀) (☾) symbols will be shown by the empty middle marker above the scale. By turning the knob the marker can be relocated between particular hours of each day of the week. The symbol of the sun fills in the empty field above the scale, whereas the symbol of the moon cancels the marking. For instance, when there is an empty field above the time limit from 21.35 to 7.15, the controller during this time will operate under the night mode. However, when the field above the time range from 7.15 to 21.35 is filled in, the controller during this period of time will operate under the daytime mode.



Selecting with the OK button the marker itself allows the user to move the marker between the particular days of the week without introducing any changes. This is extremely practical, as at any moment the user can return to any given day of the week and make a correction without cancelling the parameters set earlier. Pressing the MENU button will result in displaying the window: "Save program changes?" Select "YES" and press the knob to confirm changes, next press the MENU button and the controller will resume its regular operation. Selecting "NO" will result in recovering the earlier saved program, and pressing the MENU button will close the question window and the controller will return to the program edition mode.

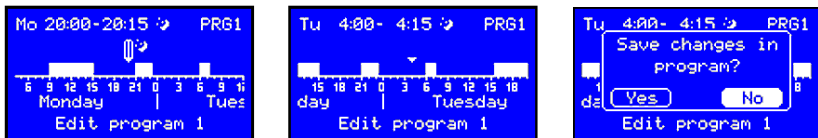

### Enforcing the change in the mode of work when under time scheduled program.

When the controller is under one of the three time scheduled programs defined by the user and it operates in the daytime mode of work, the night mode can be temporarily turned on. The same, when the controller is in the night mode of work, the daytime mode can be switched. After switching from the daytime to night mode, instead of the symbol of the sun (☀), the sign of (☾) the moon will be visible by the programmed temperature, and the ?current (e.g. PRG1) program number will blink alternately. There will appear the symbol of the moon in place of the displayed program. The change will remain active till the end of the current time limits under which the controller has been operating before the introduced changes.



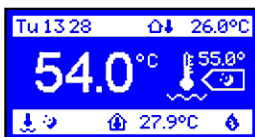

### Manual program.

Selecting the manual program while the group "Program selection" being edited results in stopping the time scheduled control. The controller will switch into the program of the continuous control. In the mode, night and daytime temperatures only are maintained with the week program deactivated.

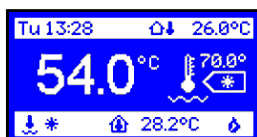
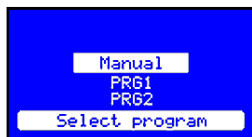

### 4. Programs copying.

The controller is provided with the function of copying programs of any given day of the week into any other day (all 1st, 2nd and 3rd programs included). The function allows to save time necessary to program the device.



Select the function "Programs copying" in the user's menu. There will be icons for each particular day of the week shown on the display. Select with the knob the day you want to copy, e.g. Monday and press the OK button. The list of the days of the week into which the selected day might be copied will be displayed. Select, e.g. Wednesday and confirm it by pressing the knob. The message "Daytime program copied" will appear - confirm it by pressing the knob again, and, to allow the controller resume its regular work, press the MENU button.

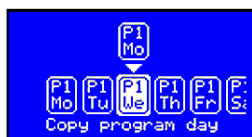

### 5. Time and date.

Select the function "Time and date" in the user's menu and, by turning the knob, change hours. To confirm the change press the knob. All remaining parameters should be treated in the same way. To exit the settings press the MENU button or set and confirm all the parameters.



## 6. Display settings.

Select the "Display settings" function in the menu to conform display to your own needs. Press the knob while the group of the parameters is edited to see



- operation lightness
- standby brightness
- contrast



## Description of service parameters.

Press and hold the MENU button for about 5 sec. to enter the service mode.

## 7. Language selection.

Select the "Language selection" function in the menu and press the OK button to allow the list of languages that could be selected. Select a language by turning the knob and confirm the change (press the knob) - the language of the program will be then changed to the selected one.



## 8. Temperature range.

Selecting the "Temperature range" function allows to set minimum and maximum values of temperature. The value of the maximum temperature set in this parameter will be both day and night maximum temperature that could be programmed, whereas the value of minimum temperature will be both day and night minimum temperature.

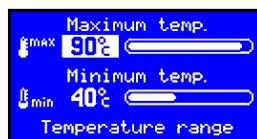

## 9. Activation threshold.

This parameter determines how much the boiler temperature must decrease relative to set temperature, so that the regulator switches on the boiler. The adjustment range is from 1 °C - to 10 °C.

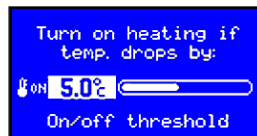

## 10. Boiler alarms.

Select the "Boiler alarms" function in the menu to set the maximum boiler temperature (temperature of overheating) and the minimum one (shortage of fuel temperature).

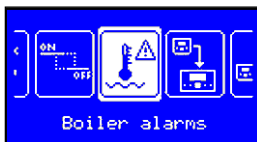

When the boiler water temperature rises above the maximum programmed temperature, the alarm will be turned on - the boiler temperature indicator and the display will start to blink. The situation will repeat as well when the boiler water temperature lowers below the minimum programmed temperature. A sound device, activated by the alarm, can be connected to the controller.

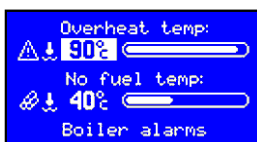

## 11. Correction of sensors.

Long connecting cables might be the reason for faulty temperature measurements. The parameter allows the user to make corrections to this malfunction. Select the "Sensors correction" function in the user's menu and make any necessary changes in the inside, outside and boiler temperature sensors. Turn the multifunctional knob in each backlit indicator to select desired values.

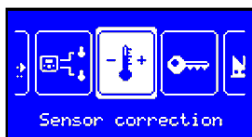

## 12. Set a password.

The parameter allows the user to set 5-digit access password to the service settings. Once the password has been typed in, the question "Save new password?" will be displayed - press the OK - and the password will be saved. In order to cancel the password, the default controller settings should be resumed



**CAUTION!** When the password has been forgotten, the user should press and hold the day/night mode of work button before the controller activation - the test screen will be displayed. Press and hold for about 10 sec. the OK button - and the question "Resume default settings?" will be shown. Select "YES" and confirm it with the OK button. To exit the test mode press the MENU button.

### 13. Default settings.

The controller is provided with three 24-hour programs and a manual one preprogrammed by the manufacturer. Select the "Default settings" in the user's menu to resume the settings. Press the knob when editing the parameter to display the question "Resume default settings?". Select YES and press the multifunctional knob to confirm the change - and the controller returns to the producer's settings

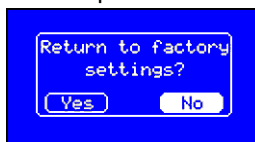

When the default settings have been resumed, the controller operates in the manual program mode. In the mode, the day and night temperatures are controlled only, with no time schedule. To activate full regulation one of the three 24-hour programs should be selected.

### 14. Antifreeze program.

The controller has been provided with the function protecting the room from freezing. When the temperature of boiler water lowers to 5 C, the burner will be activated. When the temperature rises above 5 C, the burner will be turned off and the controller will continue to protect a room from freezing

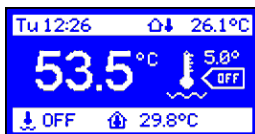

When the controller operates under one of the three week programs, press and hold for 3 sec. the (☀️🌙) button to stop the regulation. Then the controller moves to the antifreeze program and will maintain the temperature of 5 C. The "OFF" message will appear in place of the mode of work symbol, and "WYL" in place of the 24-hour program number. Additionally, the word "WYL" and the current (e.g. PRG1) program number will start to blink alternately. The change will remain active within the current time schedule under which the controller has been working, or until the button (☀️🌙) is pressed.

When the function is activated in the manual program mode, the protection from freezing works until it is turned off by pressing the change in the mode of work (☀️🌙) button.

### Technical specification:

Power supply	5÷15 V, 30 mA
Temperature measurement range	-40÷140°C
Temperature control range	20÷90°C
Temperature measurement accuracy	0.1°C
Dimensions	96x98x36 mm

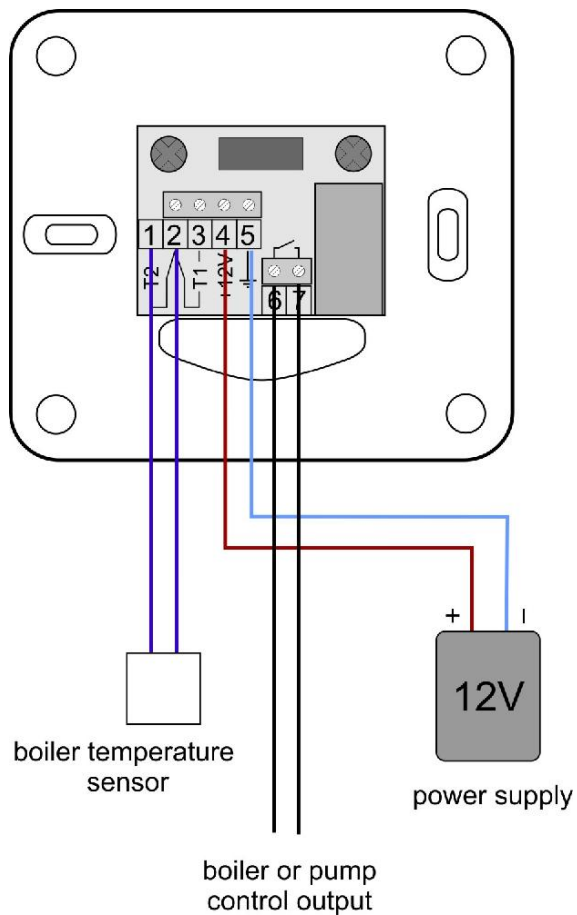

Connection diagram of the RT-208B controller to the boiler regulator.



## DECLARATION OF CONFORMITY

Manufacturer:        Przedsiębiorstwo Wielobranżowe KEY  
    Zdzisław Kluczek  
    11-200 Bartoszyce, ul. Bohaterów Warszawy 67

hereby declares that the product:

### Regulator RK-208B

is in conformity with provisions of the following directives:

2014/35/UE (LDV) of 26.02.2014r. on the harmonization laws of the Member States of the EU relating to equipment Electrical for use within certain limits, voltage,

2014/30/UE (EMC) z dnia 26.02.2016r. compatibility electromagnetic and that the following harmonized standards:

EN 60730-1:2000 (PN-EN 60730-1:2002)  
EN 60730-2-9:2010 (PN-EN 60730-2-9:2011)  
EN 61000-3-2:2006 (PN-EN 61000-3-2:2007)  
EN 61000-3-3:2008 (PN-EN 61000-3-3:2011)  
EN 55022:2010 (PN-EN 55022:2011)

mgr inż. Zdzisław Kluczek

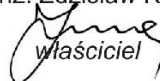

właściciel

### Information on disposal.

This appliance is marked according to the European Directive 2002/96/EC on Waste Electrical and Electronic Equipment (WEEE).



The symbol on the product, or the documents accompanying the product, indicates that his appliance may not be treated as household waste. The appliance shall be handed over to the applicable collection point for used up electrical and electronic equipment for recycling purpose. Ultimate disposal of the appliance shall follow according to applicable local regulations on waste utilization.

For more information about disposal, utilization and recycling please contact your local authorities, household waste disposal service or the shop where you purchased the product.

Manufacturer:

P.W. KEY

11-200 Bartoszyce, ul. Bohaterów Warszawy 67

tel. (89) 763 50 50, fax. (89) 763 50 51

[www.pwkey.pl](http://www.pwkey.pl) e-mail: [pwkey@onet.pl](mailto:pwkey@onet.pl)